



矩声®



element M2
element M2 S

Music Streamer

User Manual

Packing list	01
Parts and names	02
Front	02
LCD Screen	02
Rear	03
Remote control	04
Operations before using	05
Connect to network	05
MA Remote App	05
Driver for USB Audio	06
Appendix	08
Technical specifications	08
Power specifications	09
Other specifications	09
About MQA	10
About Room Ready	10
About Spotify	10

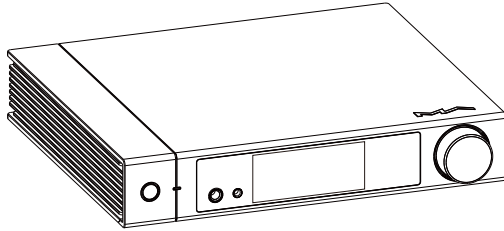

Product

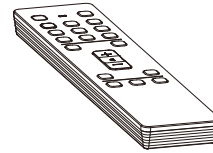

Remote control

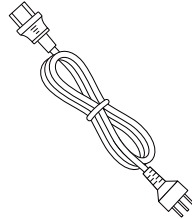

Power cable

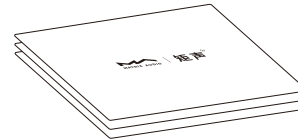

Quick start guide, warranty card

Front

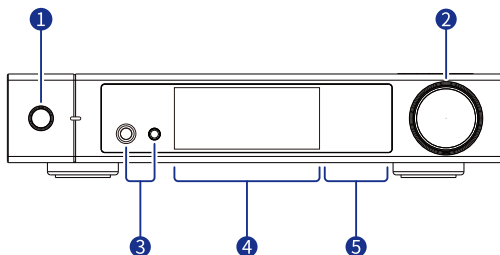
**1 Power on/Standby**

After connecting to power supply, press this button to power on the unit, press it again to let the unit standby. It takes about 30 seconds for the first start up after connecting to power supply each time.

2 Knob/Button

Set the output volume by turning the knob, when the "Lineout Mode" is set to Fixed through MA Remote App, the line output volume is not adjustable. Press the knob to mute, press the knob again or turn the knob to unmute.

3 Headphone jack (element M2)

The 6.35 mm headphone jack is for single-ended headphones, the 4.4 mm headphone jack is for balanced headphones.

4 LCD screen**5 Playback touch control area**

LCD screen

Display information

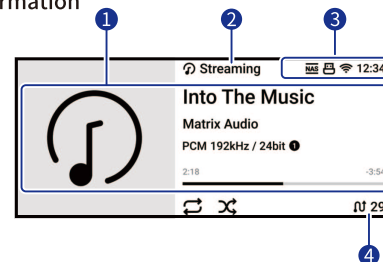
**1 Media and audio information**

Including album art, track title, artist, duration, audio format, sampling rate of the track and the filter type being used.

2 Input channel

The name of selected input channel.

3 Status

Including status of clock, network connection, USB storage, NAS and Async/Sync mode.

4 Output channel and volume

The selected output channel and volume level.

Operation of touch screen



Swipe right to open the shortcut page.

Swipe left to open the menu.

Rear

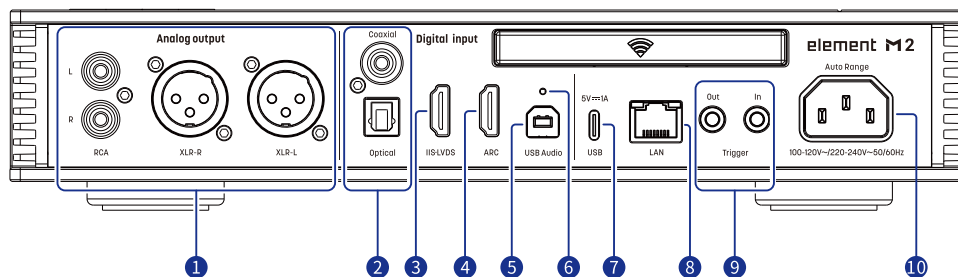
**1 Analog output**

Connect to active speakers or amplifiers through RCA or XLR cables.

2 Optical & Coaxial input

Connect to front-end devices with S/PDIF signal outputs through optical or coaxial cables.

3 IIS-LVDS input

Connect to digital interface products from Matrix Audio or other compatible devices through HDMI cables. The unit is compatible with 4 kinds of IIS-LVDS pin definitions, which can be viewed and configured in MA Remote App.

4 HDMI ARC

Connect to TVs with ARC (Audio Return Channel) functionalities through HDMI cables.

5 USB audio input

Connect to computers as an external audio device through USB Type B cables.

6 Reset button

Only use this button when the unit works incorrectly, the unit can be reset to factory state. Please operate under the instructions by service team from Matrix Audio.

7 USB Type C

Connect to USB storage devices which requires not higher than 5V/1A power supply.

8 Ethernet

Connect to LAN port of the network router, the connection supports up to Gigabit Ethernet transmission.

9 Trigger input/output

Connect to audio devices with trigger ports through a $\varnothing 3.5$ mm mono plug cables, to achieve a linkage control between the element device and other devices. The trigger output provides a 12V DC signal.

10 AC input

This unit adapt to AC100-120V and AC220-240V power supply automatically, please make sure to use the product in the power voltage range mentioned above.

* Please use the power cable which includes an earth wire. Please ensure you have a reliable earth wire connection. Otherwise, the casing of the unit may have a slightly charged touch. If you need the unit to be turned off completely, please unplug the power cable.

Remote control

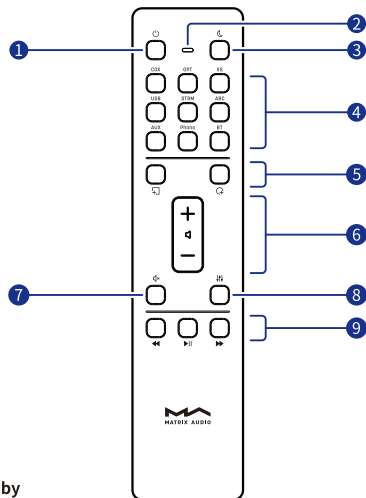
**1 Power on/Standby****2 Working/Battery status****3 Dimmer****4 Input channels**

*Some are reserved.

5 Programmable buttons

Define the functionalities of buttons through MA Remote App, they are not defined by default.

6 Volume**7 Mute/Unmute**

Press to mute, again to unmute. You also can unmute by pressing the +/- buttons in mute state.

8 Filters

Switch the corresponding filter types applied to the current playing audio format in a loop.

9 Playback control area

When the input channel supports, the playback can be controlled by these buttons.

Slide in the direction of the arrow to open the battery holder. Please pay attention to the polarity when installing the batteries.

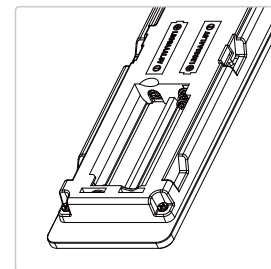
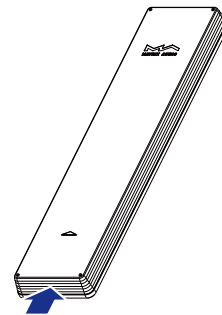

Point the remote control to the element device when using it, the operating distance is about 8 meters. When the battery is low, the LED indicator on the remote control flashes red, there will also be a notification showing on the device screen.

If there are more than one Matrix Audio device in a single environment, in order to prevent 1 remote control from controlling multiple devices at the same time, we preset 5 address codes in the remote control, these address codes can be configured in the Settings menu showing below, and follow the instructions on the screen.

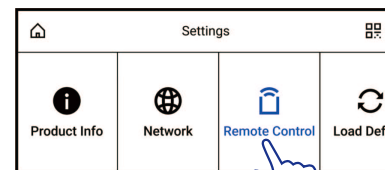

Connect to network

LAN

Connect the product to the LAN port of the network router through an Ethernet cable. It is recommended to set up the router as a DHCP server, the unit will be assigned an IP address automatically. Select "LAN" in option Network in Settings menu, you can configure the network specs manually, after joining the network, there will be a  shown in the status bar.

Wi-Fi

Enter Settings menu - Network - Wi-Fi, after network scanning complete, choose the SSID of your network and enter the passwords, there will be a  shown in the status bar after connected. The device supports 2.4GHz/5GHz wireless network.

When the connection has no Internet access, there will be a  in the status bar.

MA Remote App

Install MA Remote App for your iPad, iPhone or Android phone.



Open the app, follow the instructions to add the device to MA Remote App.

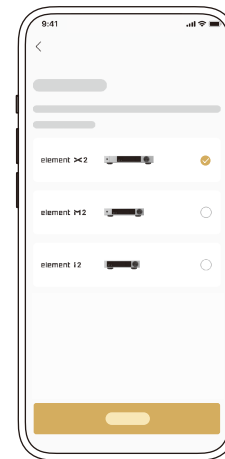

To control and configure the element device through MA Remote App, or playback streaming music from the element devices, please refer to matrix-digi.com/tutorials for instructions.



Tutorial Video

Driver for USB Audio

When connecting the device to a Windows 7/8/10/11 computer via USB connection as an external audio device, please install drivers as following instructions:

1. Double-click the driver installation package and click "Next".

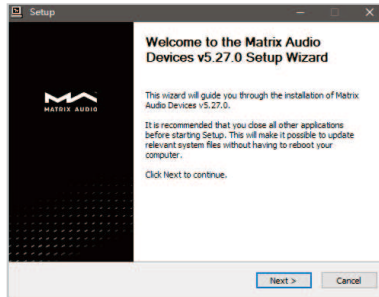

2. Select installation path and click "Install".

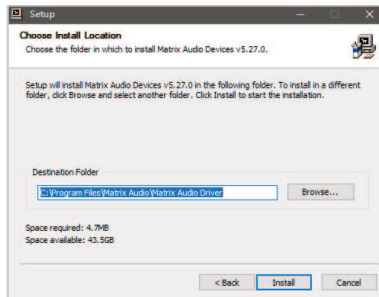

3. Click "Next" after the installation is complete.

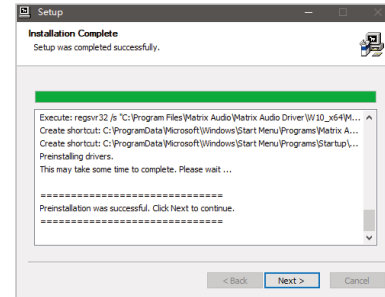

4. Click "Finish" to close the Setup Wizard.

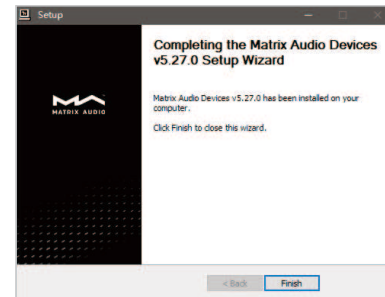

It's no need to install drivers for macOS, just select "element Series" as the audio output device in Sound Preferences.

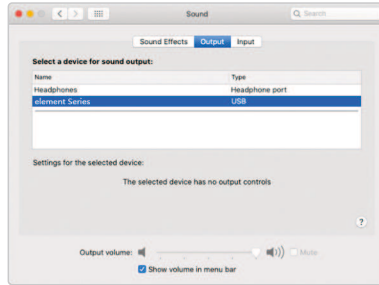

The element devices can be connected to an iPhone or iPad via a Lightning to USB Camera Adapter.

The element devices can be connected to Android devices via an OTG adapter, but not every Android device is compatible with device via OTG connection.

Technical specifications

Hardware Platform

CPU : NXP i.MX 6Quad Cortex-A9
D/A Chip : ES9028Pro
Clock Source : Crystek CCHD-950

Digital Input

Coaxial & Optical:

PCM 16-24Bit/44.1kHz, 48kHz, 88.2kHz, 96kHz, 176.4kHz, 192kHz
DSD 2.8MHz (DoP)

IIS-LVDS:

PCM 16-32Bit/44.1kHz, 48kHz, 88.2kHz, 96kHz, 176.4kHz,
192kHz, 352.8kHz, 384kHz, 705.6kHz, 768kHz
DSD 2.8MHz, 5.6MHz, 11.2MHz (DoP)
DSD 2.8MHz, 5.6MHz, 11.2MHz, 22.4MHz (Native)

USB Audio:

PCM 16-24Bit/44.1kHz, 48kHz, 88.2kHz, 96kHz, 176.4kHz,
192kHz, 352.8kHz, 384kHz, 705.6kHz, 768kHz
MQA 16-24Bit/44.1kHz, 48kHz, 88.2kHz, 96kHz, 176.4kHz,
192kHz, 352.8kHz, 384kHz MQA or MQA Studio stream
DSD 2.8MHz, 5.6MHz, 11.2MHz (DoP)
DSD 2.8MHz, 5.6MHz, 11.2MHz, 22.4MHz (Native)

HDMI ARC:

PCM 16-24Bit/44.1kHz, 48kHz, 88.2kHz, 96kHz, 176.4kHz, 192kHz

Line Output

XLR

SNR : 128dB A-weighting
THD+N : <0.00020%@1k, <0.00022%@20Hz-20kHz
Frequency Response : 20Hz-20kHz \pm 0.05 -3dB@85kHz

Crosstalk : >-145dB
Output Level : 4VRMS@0dB

RCA

SNR : 125dB A-weighting
THD+N : <0.00022%@1k, <0.00023%@20Hz-20kHz
Frequency Response : 20Hz-20kHz \pm 0.05 -3dB@85kHz
Channel Crosstalk : >-130dB
Output Level : 2VRMS@0dB

Headphone Output

4.4mm Balance d

SNR : 119dB A-weighting
THD+N : <0.00055%@20Hz-20kHz 4VRMS
Frequency Response : 20Hz-20kHz \pm 0.1 -3dB@85kHz
Output Impedance : <22 Ω
Output Power : 1800mW@33 Ω , 1100mW@300 Ω , 540mW@600 Ω , 1%THD
Gain : +18dB

6.35mm Single-ended

SNR : 116dB A-weighting
THD+N : <0.00055%@20Hz-20kHz 2VRMS
Frequency Response : 20Hz-20kHz \pm 0.1 -3dB@85kHz
Output Impedance : <11 Ω
Output Power : 1200mW@33 Ω , 280mW@300 Ω , 140mW@600 Ω , 1%THD
Gain : +18dB

Network

LAN : 10/100/1000 Mbps
WLAN : 2.4GHz/5Ghz

USB

The USB port provides a maximum power of 5V/1A.

* The USB port works with devices which conform to the USB mass storage standard and supports FAT, FAT32, exFAT, and NTFS file formats, but is not guaranteed to be compatible with all storage devices.

Trigger

Trigger in : DC 6-12V <10mA

Trigger out : DC 12V/50mA MAX

MA Player

Controller app : MA Remote App

Local Playback:

Format Supported: MP3 , WMA , WAV , AIF, AIFC, AIFF, AAC, FLAC, OGG, APE, ALAC, M4A, DSF, DFF, CUE

PCM 16-24Bit/44.1kHz, 48kHz, 88.2kHz, 96kHz, 176.4kHz, 192kHz, 352.8kHz, 384kHz, 705.6kHz, 768kHz

MQA 16-24Bit/44.1kHz, 48kHz, 88.2kHz, 96kHz, 176.4kHz, 192kHz, 352.8kHz, 384kHz MQA or MQA Studio stream

DSD 2.8MHz, 5.6MHz, 11.2MHz, 22.4MHz

Room Ready:

PCM 16-24 Bit/44.1 kHz, 48kHz, 88.2kHz, 96kHz, 176.4kHz, 192kHz, 352.8kHz, 384kHz, 705.6kHz, 768kHz

MQA 16-24 Bit/44.1 kHz, 48kHz, 88.2kHz, 96kHz, 176.4kHz, 192kHz, 352.8kHz, 384kHz MQA or MQA Studio stream

DSD 2.8MHz, 5.6MHz, 11.2MHz, 22.4MHz

AirPlay 2, DLNA/UPnP, TIDAL Connect, Spotify Connect, vTuner, Radio Paradise, the audio specs depend on the service provider.

Power specifications

Power Voltage : AC 100V-120V 50/60Hz/AC 220V-240V 50/60Hz

Standby Power Consumption : < 5W

Maximum Power Consumption : < 50W

Other specifications

Weight : 3.5 kg (7.71pounds)

Size : Width 280 mm (11.02 inches),

Depth 259 mm (10.20 inches),

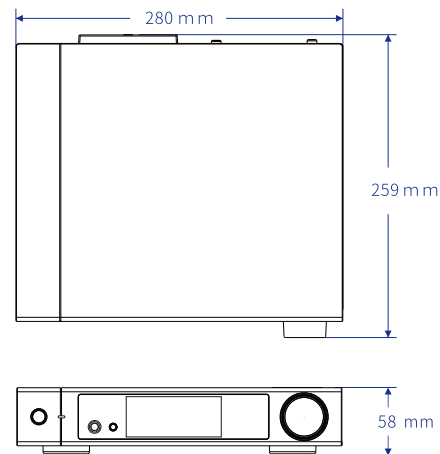

Height 58 mm (2.28 inches).



*Specifications are subject to change without notice.

About MQA (Master Quality Authenticated)

This unit includes a MQA full decoder, which enables you to playback MQA audio files via streaming or USB audio port, delivering the sound of the original master recording.

The dots beside the MQA logo green  MQA or blue  MQA to indicate that the unit is decoding and playing an MQA stream or file, and denotes provenance to ensure that the sound is identical to that of the source material. It glows blue  MQA to indicate it is playing an MQA Studio file, which has either been approved in the studio by the artist/producer or has been verified by the copyright owner.

The dot glows magenta  MQA to indicate that the unit is rendering an MQA stream or file. This delivers the final unfold of the MQA file.

*MQA and the Sound Wave Device are registered trade marks of MQA Limited. ©2016

About Roon Ready

Being Roon Ready means that Matrix Audio music streamers transparently discover and connect to Roon without any configuration, and bit-perfect audio is delivered from Roon to your music streamers.

About Spotify

Use your phone, tablet or computer as a remote control for Spotify. Go to spotify.com/connect to learn how.

The Spotify Software is subject to third party licenses found here:

<https://www.spotify.com/connect/third-party-licenses>.

- This product is for indoor use only.
- For full ventilation, it is recommended to reserve a space of larger than 5 cm around the device.
- Do not cover the air vents with stuffs such as papers, tablecloths, and curtains to obstruct ventilation.
- Do not place stuff with flame, such as lighted candles, on the device.
- If the device is used in tropical areas, please be careful to prevent insects from entering the unit through the air vents.
- The device must not be subject to water droplets or splashes. Please do not place stuffs filled with liquids such as vases and cups on or near the device.
- Do not put stuffs around the device power plug and the AC power socket, in order to disconnect the power supply easily when needed.

HIGH PERFORMANCE AUDIO

www.matrix-digi.com

Matrix Electronic Technology Co., LTD
+86-29-86211122
Room 206 Block B, #58 Mingguang Rd,
Xi'an, China

